

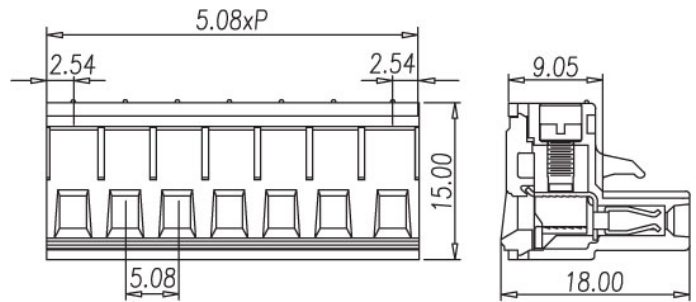



Plugs for pluggable terminal blocks / EC & ESD series



2ESDV



Pitch: 5.08mm

Approval	  	
Technical Data	UL	IEC
Rated voltage	300V	250V
Rated current	15A	17.5A
Wire range		1.5mm ²
Solid wire (AWG)	28~12	
Stranded wire (AWG/mm ²)	30~12	
Rated surge voltage (UL/IEC/Max.)	1.6 / 2 / 4 KV	
Torque (Lb-in)	4.5	
Screw	M2.5	
Wire strip length	7~8mm	
Pole	Cat. No.	
02	2ESDV-02P	
:	:	
:	:	
25	2ESDV-25P	

TEL: +886-2-2908-0614

FAX: +886-2-2908-8549

E-mail: infor@dinkle.com.tw